

Question Paper and Answer Keys for the post of Draughtsman Gr-III (Civil)

Written Recruitment Examination for filling up of the post of Draughtsman Gr-III (Civil) in APWD was held on 19/02/2023 from 9.30 am to 11.30 am at Port Blair. The Question Paper and the Answer Keys of the written examination received from the agency engaged for conduct of examination is hereby published. The candidates may submit their claims & objections if any, through email to ceapwd.recruitment@gmail.com **on or before 6th March, 2023 at 5.00 pm.**

No claims & objections will be entertained beyond the date & time mentioned above.

Date of Examination : 19.02.2023

ANSWER KEY DRAUGHTSMAN Gr-III (CIVIL)

Q.No	Key	Q.No	Key	Q.No	Key	Q.No	Key
1	B	26	B	51	A	76	D
2	A	27	A	52	A	77	D
3	B	28	A	53	B	78	C
4	C	29	B	54	D	79	C
5	B	30	B	55	C	80	C
6	B	31	B	56	B	81	D
7	C	32	D	57	D	82	B
8	C	33	B	58	D	83	D
9	C	34	D	59	B	84	C
10	C	35	A	60	C	85	A
11	B	36	D	61	D	86	B
12	C	37	A	62	B	87	D
13	B	38	C	63	C	88	C
14	C	39	D	64	B	89	C
15	D	40	C	65	D	90	D
16	C	41	D	66	D	91	B
17	C	42	D	67	C	92	B
18	D	43	D	68	B	93	C
19	A	44	C	69	B	94	A
20	B	45	D	70	C	95	D
21	B	46	D	71	B	96	D
22	C	47	C	72	C	97	B
23	C	48	A	73	C	98	A
24	B	49	B	74	A	99	B
25	D	50	A	75	A	100	C

Draftsman Gr-III (Civil) "A"
PART-I TECHNICAL SUBJECT

Q.No.	QUESTIONS
1.	What is the extension for 3D modeling file? A. 0.3d B. 0.3dm C. 0.3m D. 0.3dho
2.	Which instrument is used in reconnaissance survey for measuring the magnetic bearing of alignment of railway? A. Prismatic compass B. Theodolite C. Chain D. Level
3.	What is the full form of WCS? A. Western Co-ordinate System B. World Co-ordinate System C. Wide Co-ordinate System D. Wrong Co-ordinate System
4.	How many types of 3D modeling are in AutoCAD? A. 1 B. 2 C. 3 D. 4
5.	How many types of surfaces in surface modeling? A. 1 B. 2 C. 3 D. 4
6.	What is the name of arch having four centers? A. Elliptical B. Venetian C. Segmental

	D. Equilateral Pointed
7.	<p>What is the term for perpendicular distance between intrados and extrados?</p> <p>A. Kay B. Pier C. Rise D. Depth</p>
8.	<p>What is the arch construed over a wooden joist or flat arch?</p> <p>A. Stilted Arch B. Pointed Arch C. Relieving Arch D. Horse Shoe Arch</p>
9.	<p>What is minimum range on wall provided for timber lintel bearing?</p> <p>A. 5-8 cm B. 8-13 cm C. 15-20 cm D. 25-30 cm</p>
10.	<p>Which BIS code no. is recommended for folding of drawing sheets?</p> <p>A. IS 11664 – 1989 B. IS 11664 – 1987 C. IS 11664 – 1986 D. IS 11664 – 1981</p>
11.	<p>How many vertical folds come under 'A0' size trimmed drawing sheet?</p> <p>A. 5 B. 6 C. 7 D. 8</p>
12.	<p>What is the description of E1 hidden outlines?</p> <p>A. Dashed thin B. Chain Thin C. Dashed thick D. Chain thick</p>

13.	<p>How the dimensions can be read in aligned system of dimension technique?</p> <p>A. Left hand edge of drawing sheet B. Right hand edge of drawing sheet C. Top to bottom D. Bottom to top</p>
14.	<p>Which lime is used for construction of masonry?</p> <p>A. Class D B. Class C C. Class B D. Class A</p>
15.	<p>What is the percentage of cement water proofer in powder form for all water refining structure?</p> <p>A. 13 to 15% B. 11 to 12% C. 06 to 10% D. 02 to 05%</p>
16.	<p>Which command allows you to change the direction and origin of construction plan?</p> <p>A. Plane B. Splane C. C-Plane D. O-Plane</p>
17.	<p>What is the shortcut for polar?</p> <p>A. F8 B. F9 C. F10 D. F11</p>
18.	<p>What is the key for 3D OSNAP?</p> <p>A. F1 B. F2 C. F3 D. F4</p>
19.	<p>What is the command used to toggle between isometric planes?</p>

	<p>A. Ctrl+E B. Ctrl+F C. Ctrl+G D. Ctrl+H</p>
20.	<p>What is the command used to toggle between isometric planes?</p> <p>A. Ctrl+1 B. Ctrl+2 C. Ctrl+3 D. Ctrl+4</p>
21.	<p>What is the shortcut to cancel the last command selected?</p> <p>A. Ctrl+] B. Ctrl+[C. Ctrl+} D. Ctrl+,</p>
22.	<p>What is the shortcut for rendering an image?</p> <p>A. RS B. RSP C. RP D. RW</p>
23.	<p>What is the rise in level of the river water due to obstruction of bridges?</p> <p>A. Highest flood level B. Run off C. Afflux D. Free Board</p>
24.	<p>What is the intermediate support of a bridge superstructure?</p> <p>A. Foundation B. Pier C. Abutment D. Wing wall</p>
25.	<p>Which is the temporary pier made in the river bed?</p> <p>A. Kerb B. Scuppers</p>

	<p>C. Afflux D. Cribs</p>
26.	<p>What is the minimum distance between the specified position on a bridge?</p> <p>A. Bearings B. Clearance C. Afflux D. Water way</p>
27.	<p>Which foundation is suitable for the construction of bridge?</p> <p>A. Pile B. Shallow C. Grillage D. Inverted arch</p>
28.	<p>What is the name given to build up area of building measured at floor level of any story?</p> <p>A. Plinth area B. Floor area C. Circulation Area D. Carpet area</p>
29.	<p>What percentage of plinth area is provided for horizontal circulation area?</p> <p>A. 5 to 10% B. 10 to 15% C. 15 to 20% D. 20 to 25%</p>
30.	<p>What percentage of plinth area of the residential building comes to carpet area?</p> <p>A. 40 to 55% B. 50 to 65% C. 60 to 75% D. 70 to 85%</p>
31.	<p>What percentage of estimated cost is charged for centage charges?</p> <p>A. 5 to 10% B. 10 to 15%</p>

	<p>C. 15 to 20%</p> <p>D. 20 to 25%</p>
32.	<p>AutoCAD was first released in the year:</p> <p>A. 1858</p> <p>B. 1966</p> <p>C. 1898</p> <p>D. 1982</p>
33.	<p>Which mode allows the user to draw 90° straight lines :</p> <p>A. Osnap</p> <p>B. Ortho</p> <p>C. Linear</p> <p>D. Polar tracking</p>
34.	<p>To obtain parallel lines, concentric circles and parallel curves; _____ is used.</p> <p>A. Array</p> <p>B. Fillet</p> <p>C. Copy</p> <p>D. Offset</p>
35.	<p>The default grid spacing in both X and Y directions is:</p> <p>A. 10</p> <p>B. 20</p> <p>C. 5</p> <p>D. 15</p>
36.	<p>Which command is used to divide the object into segments having predefined length?</p> <p>A. Divide</p> <p>B. Chamfer</p> <p>C. Trim</p> <p>D. Measure</p>
37.	<p>How many grip points does a circle have?</p> <p>A. 5</p> <p>B. 4</p> <p>C. 3</p> <p>D. 2</p>

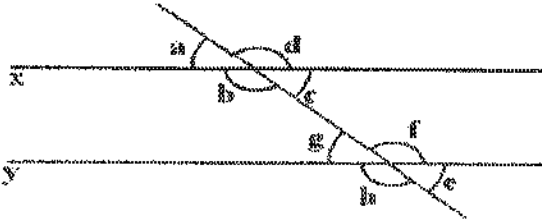

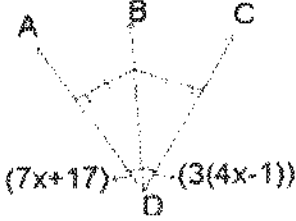
38.	<p>Which of the following is not a line segment?</p> <p>A. Bamboo B. Ruler C. Laser beam D. Pencil</p>
39.	<p>Which of the property given below is false regarding a square?</p> <p>A. A square is a particular case of a rectangle and a rhombus simultaneously B. A square is a parallelogram with right angles and equal sides C. The diagonals of a square cut at 90 degree D. A square is a particular case of a rectangle only</p>
40.	<p>If you are given only a compass and a ruler which angle is not possible to construct?</p> <p>A. 37.5 B. 33.75 C. 40 D. 120</p>
41	<p>N number of circles are formed with a common centre, what is that geometry called?</p> <p>A. Inscribed circle B. Sphere C. Circumscribed circle D. Concentric circle</p>
42	<p>Which geometric principle is used to justify the construction below?</p>  <p>A. A line perpendicular to one of two parallel lines is perpendicular to the other B. Two lines are perpendicular if they intersect to form congruent</p>

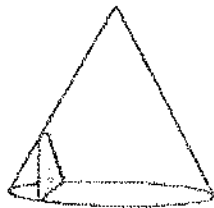
	<p>adjacent angles</p> <p>C. When two lines are intersected by a transversal and alternate interior angles are congruent, the lines are parallel</p> <p>D. When two lines are intersected by a transversal and the corresponding angles are congruent, the lines are parallel</p>
43	<p>Find angle BDC shown in the figure below.</p>  <p>A. 30 B. 65 C. 60 D. 45</p>
44.	<p>The front and top view are sometimes not sufficient to convey all the information regarding the object. Additional views are therefore projected on other planes known as _____</p> <p>A. Auxiliary vertical plane B. auxiliary inclined plane C. auxiliary plane D. horizontal and Vertical plane</p>
45.	<p>Auxiliary views cannot be used for the determining _____</p> <p>A. the true length of a line B. the point-view of a line C. the edge-view of a line D. the apparent size</p>
46.	<p>Parabolic curves is not used in _____</p> <p>A. Arches B. Bridges C. Sound reflectors D. Boring</p>
47.	<p>By an equation how can you define a cycloid?</p> <p>A. $y = a(1 - \sin \alpha)$ B. $x = a(\alpha - \cos \alpha)$</p>

	<p>C. $x = a(\alpha - \sin \alpha)$ D. $x = a(1 - \sin \alpha)$</p>
48.	<p>When the point is within the circle, the curve is called an _____</p> <p>A. Inferior trochoid B. Superior trochoid C. Inscribed trochoid D. Superior trochiod</p>
49.	<p>Figure below represents a section (shaded) obtained due to intersection by a plane that is parallel to the axes of the cones, what is the section called?</p>  <p>A. Parabola B. Hyperbola C. Ellipse D. Cycloid</p>
50.	<p>For eccentricity in ellipse (e) which relation is correct?</p> <p>A. $e < 1$ B. $e = 1$ C. $e > 1$ D. $e = \infty$</p>
51.	<p>When a uniform and flexible chain hangs from two pegs, its weight is uniformly distributed along its length. The shape it takes is called a _____</p> <p>A. Catenary B. Parabola C. Hyperbola D. Ellipse</p>
52.	<p>A curve defined by an equation $x^2/a^2 + y^2/b^2 = 1$ is known as _____</p> <p>A. Ellipse B. Directrix</p>

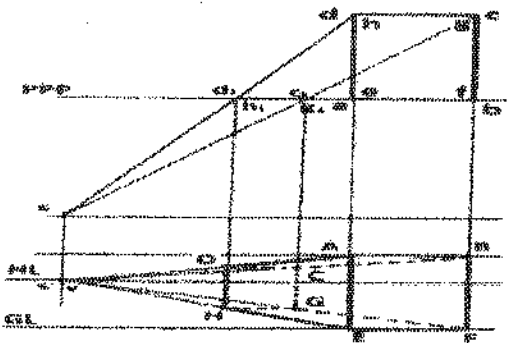
	<p>C. Parabola D. Hyperbola</p>
53.	<p>The curve generated by a point fixed to a circle outside its circumference as it rolls along a straight line is called a _____</p> <p>A. Inferior epitrochoid B. Superior trochoid C. Inferior trochoid D. Superior epitrochoid</p>
54.	<p>The curve generated by a point fixed to a circle outside its circumference as it rolls along a circle outside it, is called _____</p> <p>A. Inferior epitrochoid B. Superior trochoid C. Inferior trochoid D. Superior Epitrochoid</p>
55.	<p>The front view obtained on the development of a square pyramid from its plan and front elevation which stands vertically on its base on H.P with one edge of the base parallel to V.P?</p> <p>A. Square B. Triangle C. Trapezium D. Rectangle</p>
56.	<p>The top view obtained by the development of a square pyramid from its plan and front elevation which stands vertically on its base on H.P with one edge of the base parallel to V.P. will be?</p> <p>A. Triangle B. Square C. Trapezium D. Circle</p>
57.	<p>Which method is used for development of a sphere?</p> <p>A. Parallel-line development B. Radial-line development C. Triangulation development D. Approximate method</p>
58.	<p>The nature of surface of sphere is _____</p>

	<p>A. plane surface B. singly curved surface C. singly or doubly curved surface D. doubly curved surface</p>
59.	<p>When an object is viewed from different directions and at different distances, the appearance of the object will be different. Such view is called _____</p> <p>A. oblique projection B. perspective view C. axonometric projection D. isometric projection</p>
60.	<p>It is the line drawn through the station point and perpendicular to the picture plane. It is also called axis of vision or line of sight or _____</p> <p>A. Station point B. X-axis C. Perpendicular axis D. Z-axis</p>
61.	<p>These are points at which the edges of the object appear to be converging. This point is seen at eye level, i.e. on HP are _____</p> <p>A. Station point B. Piercing point C. Exit point D. Vanishing point</p>
62.	<p>The figure below represents _____ of a rectangular prism with one face in PPP.</p>  <p>A. 2- point perspective view B. 1-point perspective view</p>

	<p>C. 3- point perspective view D. 4- point perspective view</p>
63.	<p>Which types of prism does the 3rd figure represents?</p>  <p>A. Triangular B. Square C. Pentagon D. Oblique</p>
64.	<p>When the prism is placed vertically on one of its end faces, the end face on which the prism rests is called the _____ and the vertical side faces are the _____ faces.</p> <p>A. bottom, lateral B. base, lateral C. base, longitudinal D. horizontal, lateral</p>
65.	<p>When the axis of the pyramid is perpendicular to its base, which pyramid does it represent?</p> <p>A. Perpendicular pyramid B. Square pyramid C. Oblique pyramid D. Right pyramid</p>
66.	<p>When the receding lines are true length, and the projectors are at 45 degrees to the plane of projection, the oblique drawing is called _____</p> <p>A. oblique projection B. isometric projection C. axonometric projection D. cavalier projection</p>
67.	<p>What is the general application of the line shown below?</p>  <p>A. Hidden edges B. Extension</p>

	<p>C. Cutting planes D. Projection</p>
68.	<p>In lettering 'A' the height of capital letter is divided in how many parts?</p> <p>A. 10 B. 14 C. 16 D. 8</p>
69.	<p>The length to height ratio of a closed filled arrow head is?</p> <p>A. 1:3 B. 3:1 C. 1:2 D. 2:1</p>
70.	<p>For 2.5 cm thick c.c. floor of 1:2:4 proportion, for 100 sq m, what amount of stone aggregate will be required?</p> <p>A. 5.20 cu m B. 1.20 cu m C. 2.40 cu m D. 20 cu m</p>
71.	<p>For 2.5 cm c.c. floor for 100 sq m of area and 10% for contingency what amount of cement concrete will be required?</p> <p>A. 5.75 cu m B. 2.75 cu m C. 2.5 cu m D. 5.0 cu m</p>
72.	<p>Taking 'A' as the FRONT VIEW. Which view will letter 'D' represent in the following figure?</p>

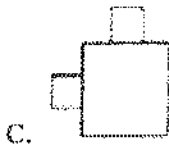
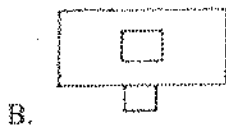
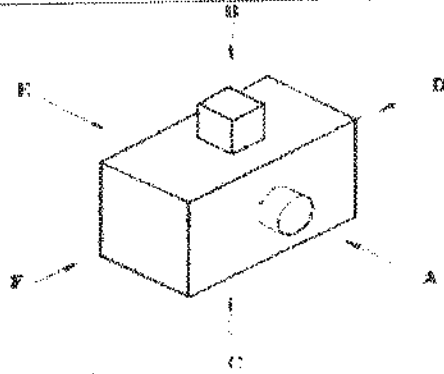

73. A body consists of numerous particles on which the pull of the earth, i.e. the forces of gravity act. The resultant of these forces acts through point. This point is called the _____ of the body.

- A. centroid
- B. neutral axis
- C. centre of gravity
- D. gravity



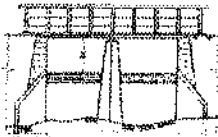

74. In AutoCad in order to measure the dimensions of a land, the surveyor uses which of the following system,

- A. no one method
- B. related cartesian coordinates
- C. absolute polar coordinates
- D. none of the above

75.	<p>Which is the linear method of setting out a simple circular curve?</p> <p>A. successive bisection of arcs B. two theodolite method C. tachometric method D. Rankin's method</p>
76.	<p>What is the minimum shoulder width recommended by IRC?</p> <p>A. 1.30m B. 1.85m C. 2m D. 2.5m</p>
77.	<p>Which culvert is used if the water opening is less than $15m^2$ and road crosses the water way on a relatively high embankment?</p> <p>A. Pipe B. Arch C. Box D. Slab</p>
78.	<p>Which bridge composed of several small spans for crossing a valley?</p> <p>A. Aqueduct B. Fort C. Viaduct D. Deck</p>
79.	<p>Which is a temporary structure constructed to remove water or soil from an area to carry construction under dry condition?</p> <p>A. Caisson B. Well C. Cofferdam D. Box</p>
80.	<p>What is marked as 'x'?</p>  <p>A. Clearance</p>

	B. Approach C. Free board D. Apron
--	--

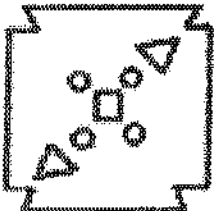
Draftsman Gr-III (Civil) "A" PART-II GENERAL INTELLIGENCE AND REASONING	
S.No.	Questions
81.	AYD, BVF, DRH, ?, KGL A. FMI B. GMJ C. HLK D. GIJ
82.	A person gives $\frac{1}{4}$ of his property to his daughter, $\frac{1}{2}$ to his sons and $\frac{1}{5}$ for charity. How much has he given away? A. $\frac{1}{20}$ B. $\frac{19}{20}$ C. $\frac{1}{10}$ D. $\frac{9}{10}$
83.	Pituitary : Brain :: Thymus : ? A. Larynx B. Spinal Cord C. Throat D. Chest
84.	A, CD, GHI, ?, UVWXY A. LMNO B. MNO C. MNOP D. NOPQ
85.	LXF, MTJ, NPN, OLR, ? A. PHV B. PIU

	<p>C. PJW D. PKX</p>
86.	<p>If 'GIVE' is coded as 5137 and 'BAT' is coded as 924, how is 'GATE' coded?</p> <p>A. 5427 B. 5724 C. 5247 D. 2547</p>
87.	<p>A square paper is folded and cut as shown below. How will it appear when unfolded?</p>  <p>(A) </p> <p>(B) </p> <p>(C) </p> <p>(D) </p> <p>A. A B. B C. C D. D</p>
88.	<p>A jogger running at 9 kmph alongside a railway track in 240 meters ahead of the engine of a 120 meters long train running at 45 kmph in the same direction. In how much time will the train pass the jogger?</p>

	<p>A. 3.6 sec</p> <p>B. 18 sec</p> <p>C. 36 sec</p> <p>D. 72 sec</p>
89.	<p>If '×' stands for 'addition', '<' for 'subtraction', '+' for 'division', '>' for 'multiplication' '−' for 'equal to', '−' for 'greater than' and '=' for 'less than', then state which of the following is true?</p> <p>A. $3 \times 4 > 2 - 9 + 3 < 3$</p> <p>B. $5 \times 3 < 7 \div 8 + 4 \times 1$</p> <p>C. $5 > 2 + 2 = 10 < 4 \times 8$</p> <p>D. $3 \times 2 < 4 \div 16 > 2 + 4$</p>
90.	<p>35, 29, 24, 20, ?...</p> <p>A. 14</p> <p>B. 15</p> <p>C. 16</p> <p>D. 17</p>
<p>Draftsman Gr-III (Civil) "A"</p> <p>PART-II GENERAL AWARENESS</p>	
S.No.	Questions
91.	<p>According to which health authority, fully vaccinated people do not need to wear masks?</p> <p>A. ICMR</p> <p>B. CDC</p> <p>C. EMA</p> <p>D. NHS</p>
92.	<p>Which IIT has launched the 'Nilekani Centre at AI4Bharat' to promote Indian language technology?</p> <p>A. IIT Hyderabad</p> <p>B. IIT Madras</p> <p>C. IIT Bombay</p> <p>D. IIT Kanpur</p>
93.	<p>Who has won silver in the women's Judo 48kg final at Commonwealth</p>

	<p>Games 2022?</p> <p>A. Mirabai Chanu B. Bindyarani Devi C. Shushila Devi Likmabam D. Harjinder Kaur</p>
94.	<p>In West Bengal, the state government is creating 7 new districts. What will be the total number of districts in the state now?</p> <p>A. 30 B. 21 C. 26 D. 37</p>
95.	<p>Which telecom company is ready to roll out the World's Most Advanced 5G network across India?</p> <p>A. Airtel B. Adani C. Vodafone D. Reliance Jio</p>
96.	<p>Which state has won the Khelo India Youth Games 2021 title with 52 gold medals on the final day?</p> <p>A. Tamil Nadu B. Gujarat C. Karnataka D. Haryana</p>
97.	<p>Which smart city is the first smart city in India to receive data from Google's EIE?</p> <p>A. Srinagar smart city B. Aurangabad smart city C. Pune smart city D. Kochi smart city</p>
98.	<p>Satyendra Prakash has been appointed as the Principal Director General of</p>

	<p>the Press Information Bureau. The Press Information Bureau has established in which year?</p> <ul style="list-style-type: none">A. 1919B. 1895C. 2000D. 1992
99.	<p>Pacific Dragon ballistic missile defense exercise is a biennial drill held between three major countries. Which country is not a part of this exercise?</p> <ul style="list-style-type: none">A. JapanB. PhilippinesC. United StatesD. South Korea
100.	<p>'The Crafts Village scheme' is an initiative of which Union Ministry?</p> <ul style="list-style-type: none">A. Union Ministry of Home AffairsB. Union Ministry of MSMEC. Union Ministry of TextilesD. Union Ministry of Culture